

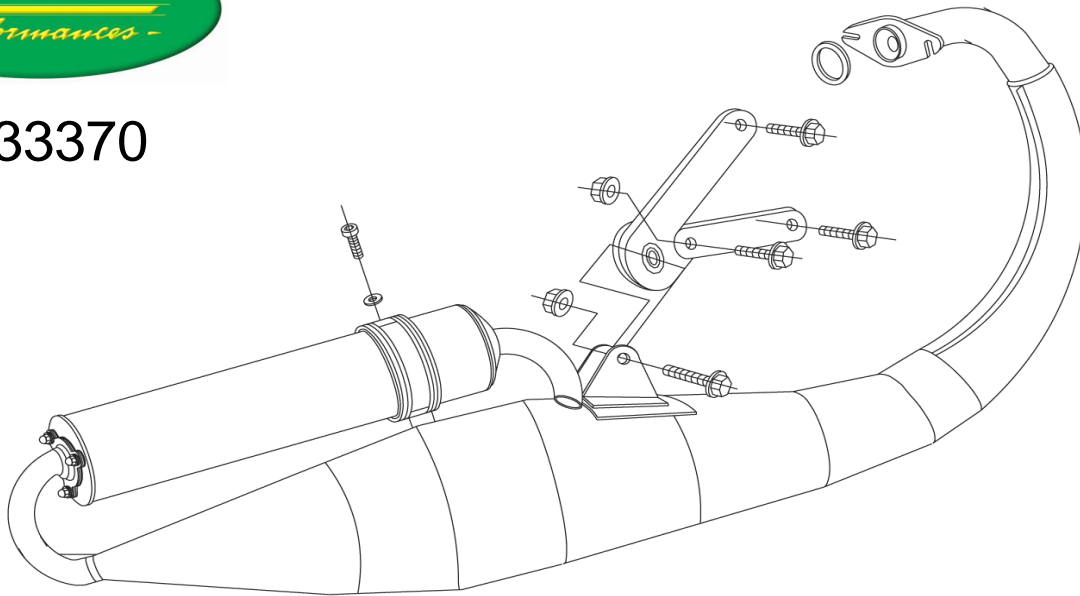

9933370



**RULLI E MOLLE-ROLLERS AND SPRINGS-MASSELOTTES ET RESSORTS-ROLLEN UND FEDERN-RODILLOS Y MUELLES**

**Rulli:** (art. 4645 – gr. 4,3 per MBK BOOSTER - YAMAHA BW'S, art. 4645 - gr. 5,8 per NEXT GENERATION e RULLI ORIGINALI per YAMAHA BW' S 50 KAT). **Molle:** (MINARELLI HARD GIALLE).  
**Rollers:** (art 4645 – 4,3 g. for MBK BOOSTER - YAMAHA BW'S, art. 4645 -5,8 g NEXT GENERATION and ORIGINAL ROLLERS for YAMAHA BW'S 50 KAT). **Springs:** (MINARELLI HARD GIALLE).  
**Masselottes:** (ref. 4645 - 4,3 grammes pour MBK BOOSTER - YAMAHA BW'S, ref. 4645- 5,8 grammes pour NEXT GENERATION et ORIGINAL MASSELOTTES pour YAMAHA BW'S 50 KAT). **Ressort:** (MINARELLI HARD JAUNES).  
**Rodillos:** (art. 4645 – gr 4,3 para MBK BOOSTER - YAMAHA BW'S, art. 4645 – gr 5,8 para NEXT GENERATION y ORIGINAL RODILLOS para YAMAHA BW'S 50 KAT ). **Muelles:** (MINARELLI HARD GIALLE).  
**Rollen:** (Art. 4645 - gr. 4,3 für MBK BOOSTER - YAMAHA BW'S, Art. 4645 gr. 5,8 für NEXT GENERATION und ORIGINAL ROLLEN für YAMAHA BW'S 50 KAT). **Federn:** (MINARELLI HARD GELBE).

**DISEGNO TECNICO RULLI E MOLLE - TECHNICAL DRAWING ROLLERS AND SPRINGS  
 CROQUIS TECHNIQUE MASSELOTTES ET RESSORTS - TECHNISCHE ZEICHNUNG ROLLEN UND FEDERN  
 DISEÑO TÉCNICO RODILLOS Y MUELLES**

FIGURA 1

- \* Battuta rullo
- \* Roller beat
- \* Retour plastique
- \* Anschlag der rolle
- \* Batiante de rodillo



FIGURA 2

Senso di rotazione  
 Clock-wise rotation  
 Sens de rotation  
 Drehrichtung  
 Sentido de rotación

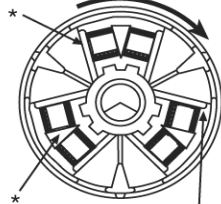

- \* Battuta rullo
- \* Roller beat
- \* Retour plastique
- \* Anschlag der rolle
- \* Batiante de rodillo

MOLLE DA SOSTITUIRE - SPRINGS TO BE REPLACED  
 RESSORTS À REMPLACER - ZU ERSETZENDE FEDER  
 MUELLES PARA SUSTITUCIÓN

FIGURA 3

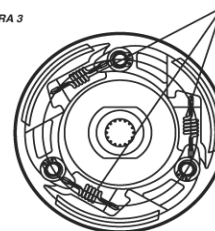

Frizione a 3 molle  
 3 springs clutch  
 Embrajage à 3 molle  
 3-feder-kupplung  
 Friccion con 3 muelles

FIGURA 4

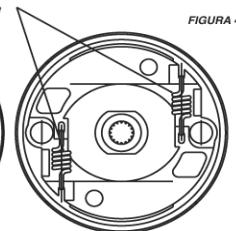

Frizione a 2 molle  
 2 springs clutch  
 Embrajage à 2 ressorts  
 2-feder-kupplung  
 Friccion con 2 muelles

VISTA DAL LATO INTERNO - VIEW FROM THE INNER SIDE  
 VUE DE L'INTÉRIEUR - ANSICHT VON INNENSEITE  
 VISTA DESDE EL LADO INTERIOR



Société Nationale de  
Certification et d'Homologation  
Société à responsabilité limitée











October 14<sup>th</sup>, 2010

## STATEMENT

We confirm, that the following replacement silencer type 4588, produced by SITO Gruppo Industriale S.p.A. (S.G.I.), is complying with

- the EC-Directive 97/24/EC Chapter 9 regarding permissible sound level and exhaust system

An EC type approval number has been granted by the luxembourgian Ministry for Sustainable Development and Infrastructure, department of Transport, for the following version of the above mentioned replacement silencer type:

Silencer Version	Drawing No.	Type approval number	Vehicle type	Vehicle Model
4579	4579	SGI  0459 	3WW (CW50) - 4BX - 4PA1 - 4WW - VG5SA062001 - 5LE2	MBK Booster 50
4579	4579	SGI  0459 	5NT - VG5SA - 5SX - 5SX1	MBK Booster 50 kat
4579	4579	SGI  0459 	4TD - 4SB - 4VA - VG5SA052001 - 5LF1	MBK Booster 50 Next Generation
4579	4579	SGI  0459 	5FL - 5NU	MBK Booster Next Generation 50 kat
4579	4579	SGI  0459 	SA06	MBK Spirit
4579	4579	SGI  0459 	5LE - 5MM	MBK Spirit Kat
4579	4579	SGI  0459 	5LH	MBK Stunt
4579	4579	SGI  0459 	4SB - 4VA	MBK Rocket
4579	4579	SGI  0459 	SA051 - SA052 - SA054 - SA055 - SA056 - SA057 - SA058 - 5NT - VG5SA - 5SX - 5SX1	YAMAHA BW'S kat
4579	4579	SGI  0459 	5FL - 5NU	YAMAHA BW'S Next Generation kat
4579	4579	SGI  0459 	3WW (CW50)-4BX-4VU2-VG5SA061001-5LE1 - VGASA056 - VGASA057	YAMAHA BW'S 50
4579	4579	SGI  0459 	4TD - 4SB/4VA - VG5SA - 5LF1 - NP4YB200 - 4VA	YAMAHA BW'S Next Generation
4579	4579	SGI  0459 	SA09 - SA - SA091	YAMAHA Slider 50 kat
4579	4579	SGI  0459 	4UP	YAMAHA Spy

Gilles AST  
Expert Technique

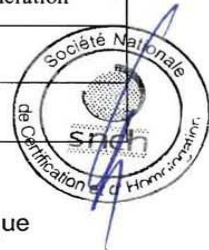

Adresse:  
BP 23  
L-5201 Sandweiler

Siège social:  
11, route de Luxembourg  
L-5230 Sandweiler

Capital social: 3.500.000 €  
R.C. B 27180  
N° TVA: LU 13770825

Tél.: (+352) 35 72 14 - 250  
Fax: (+352) 35 72 14 - 244  
E-mail: [info@snch.lu](mailto:info@snch.lu)  
Home page: [www.snch.lu](http://www.snch.lu)